

KS1150 Corner 400 Gas Fireplace

Information Sheet for Builders and Architects

MODE

SPECIFICATIONS

Heat Output	6.6kw
Gas Input	33 MJ/hr (NG) 33 MJ/hr (ULPG/Propane)
Gas Connection	Lower rear of fireplace - 1/2" BSPT Female
Gas Type	Natural Gas or Propane/ULPG
Power Requirement	3 pin, 230V AC mains power within 1m
Operation	Thermostatic IR remote control
Appliance Weight	140kg
Connections	Lower rear of fireplace
Clearance to Combustibles	Zero clearance from fireplace surfaces
Service Access Hatch	Not Required
Cavity Wall Venting	Not Required
Certification	Complies with AS/NZS 5263.1.3
Flue System	Power direct-vent with co-linear 100/75mm \varnothing flexible and rigid PP flue pipes*



Flue Termination Locations	Roof or wall mounted terminations
Minimum Flue Length	400mm
Max. Uninsulated Flexible Flue Length	8m
Max. Insulated Flexible Flue Length	20m*
Max. Flue Length	40m*
Flue Clearances to Combustibles	50mm for the first 1.2m of flue run
Flue Bends Allowed	Max. 10 bends in any flue run

CAVITY INSTALLATION OPTION

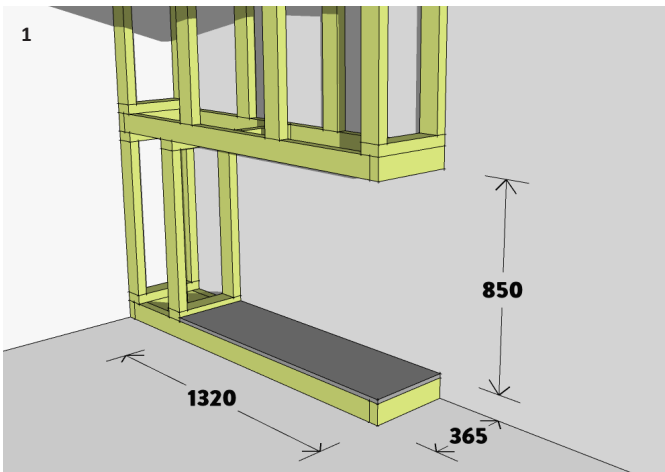

Build the chimney framework with consideration to flue pathways and meet the minimum fireplace opening requirements (850mm H x 1320mm W x 365mm D). Ensure a continuous base for the fireplace.

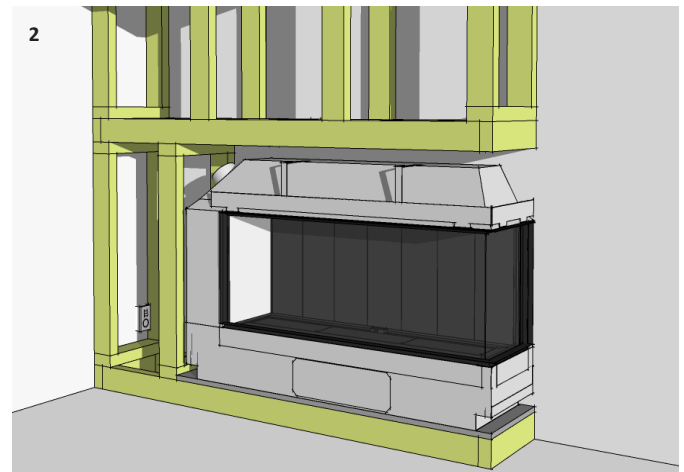

Install the appliance into the preformed cavity opening and secure it to the base. Ensure the fireplace is flush with the framework. Provide mains power connection and an accessible isolation switch.

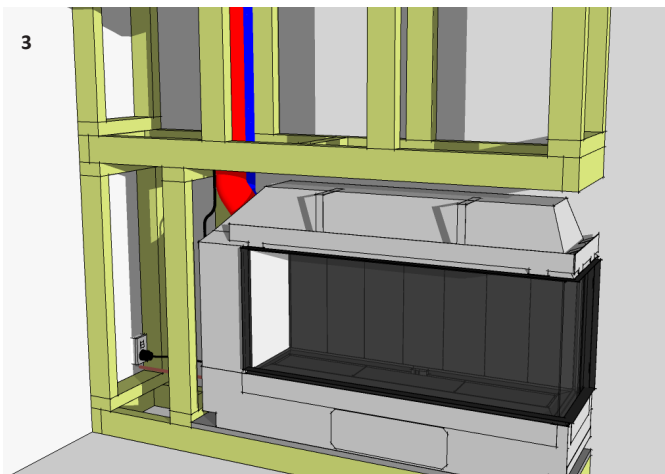

Install electrical, network connections, and gas supply. Connect flue pipes to the fireplace and create the flue pathway to the terminal. Connect Powerflue electrical cable at both ends.

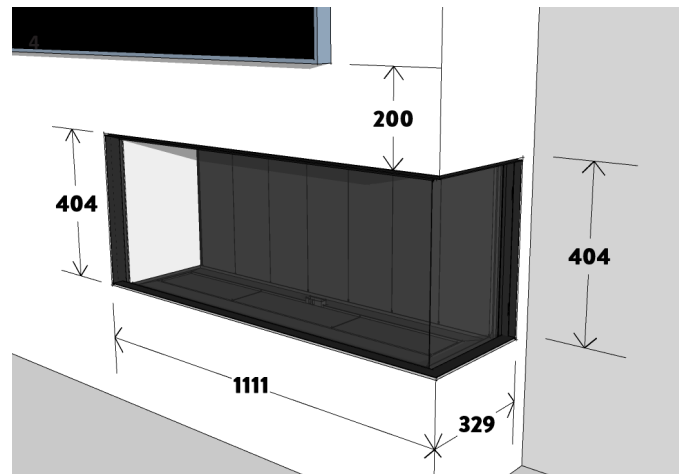

Attach wall linings to the framework and fireplace, maintaining a 5mm gap from the fireplace trim. Follow the provided wall lining cutout dimensions above. Complete the project by adding additional finishes or fixtures.

*Refer to the Mode KS1150 Corner Flue Specification Guide

KS1150 Corner 400 Gas Fireplace

Information Sheet for Builders and Architects

MODE

CAVITY OPTIONS

Please Note: the KS1150 Gas fireplace is non-load-bearing, make sure to provide sufficient support for any framework or building components above it.

The KS1150 Corner gas fireplace is versatile for room installation in different configurations. It fits beneath counters or cabinetry with a capped framework at the minimum cavity height. The cavity can be made from various materials, both combustible and non-combustible. Extra heat protection might be necessary for recessing or joinery specifications.

NOTE: Available as an accessory, the **Kitset Wall Unit (KWU)** can assist in installation of the KS1150 Corner and Peninsula models. This metal support structure simplifies setup and can hold up to 500kg of framework and cladding without transferring load to the fireplace.

CONFIGURATION OPTIONS

The KS1150 Corner gas fireplace is available in both left and right corner options, with the short side of glass positioned to the left for the left option and to the right for the right option, when facing the fireplace.

FIREPLACE BASE

Install the fireplace on a minimum 12mm firm, continuous surface like a concrete floor, plywood, or compressed cement sheet. Avoid installing directly on carpet, rugs, or heat-sensitive floor finishes.

TV CLEARANCE

When mounting a TV or electrical appliance above a fireplace, this can be completed surface-mounted or recessed. Ensure the TV's base is at least **200mm** above the glass viewing area. Note that TV clearance recommendations are suggestions only, and Escea is not responsible for their compatibility with all electrical appliances.

FIREPLACE AND CAVITY DIMENSIONS

Fireplace Width (A) including 22mm finish trim	1296mm
Fireplace Height (B)	795mm
Fireplace Depth (C) including 22mm finish trim	378mm
Framed Cavity Opening Width min.	1320mm
Framed Cavity Opening Height min.	850mm
Framed Cavity Opening Depth min.	350mm

FIREPLACE CLEARANCES TO COMBUSTIBLES

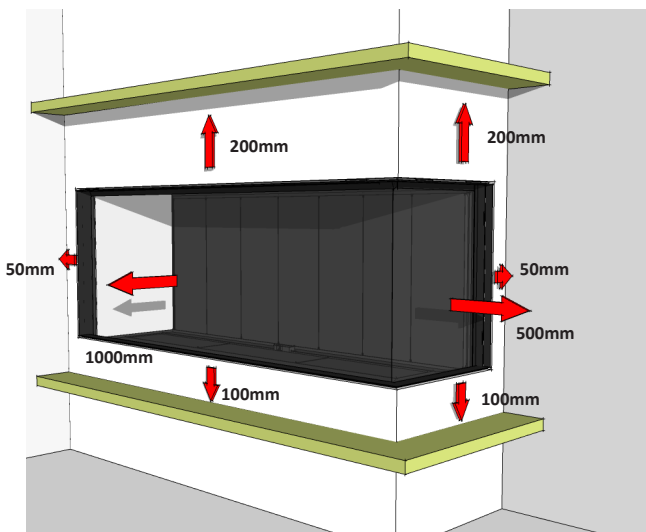

FINISHES

Use **18 - 20mm deep wall linings or finishes**, taking care to select materials suitable for the installation. Prevent combustible or heat sensitive wall linings from extending forward or beneath the 22mm fireplace trim.

Maintain a 3mm gap (+/- 2mm) to the fireplace's finishing trim.

Replace the 22mm fireplace trim with the **36mm Extended Trim Kit** or a custom solution, for adequate heat protection. Prolonged heat exposure may damage the appearance or long-term performance of wall linings.

For specific finish details, refer to: www.stokefires.com/fireplace-specification

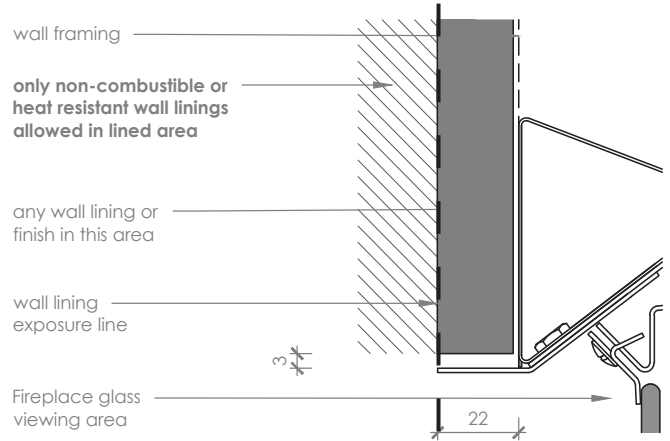

*This detail is applicable for all sides of the fireplace viewing area.

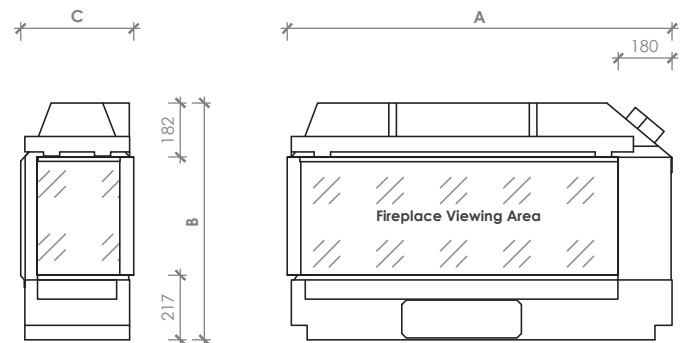

Ensure all clearances are met to any combustible or heat sensitive materials in front, above, to the side, or below the fireplace viewing area. Following these clearances, will allow the use of standard building materials, whether combustible or non-combustible. To reduce these clearances, use non-combustible materials.

Ensure that any combustible mantels or protruding ledges above the fireplace are positioned at least **200mm** above the viewing area. Mantel height depends on its depth; the greater the protrusion, the higher the clearance. For more details, check the *Mode KS1150 Corner 400 Install Manual* at: www.stokefires.com/fireplace-specification

A hearth is not necessary, but if used, a combustible hearth must be at least **100mm** below the glass viewing area or made entirely of non-combustible materials.

Install in accordance with *AS/NZS5601.1* and the *Mode KS1150 Corner 400 Install Manual*. Contractors and installers should verify all dimensions on site prior to the manufacture or construction of any structure or finishes.

FURTHER INFORMATION

Where an installation scenario is not covered within this document or the *Mode KS1150 Corner 400 Install Manual*, please contact the Escea Architectural Advisory Team for further assistance.

Email: aa@escea.com

PH (NZ): **0800 17 3000**

PH (AU): **1800 460 832**