

SPECIFICATIONS

Heat Output	9.7kw
Gas Input	49 MJ/hr (NG), 47 MJ/hr (ULPG/Propane)
Gas Connection	Lower rear of fireplace - 1/2" BSPT Female
Gas Type	Natural Gas or Propane/ULPG
Power Requirement	3 pin, 230V AC mains power within 1m
Operation	Thermostatic Bluetooth remote control
Appliance Weight	191kg
Connections	Mid-right side of fireplace
Clearance to Combustibles	Zero clearance from fireplace surfaces
Service Access Hatch	Not Required
Cavity Wall Venting	Not Required
Certification	Complies with AS/NZS 5263.1.3
Flue System	Power direct-vent with 100/75mm flexible and rigid PP flue pipes*



Flue Termination Locations	Roof or wall mounted terminations
Minimum Flue Length	1200mm
Max. Uninsulated Flexible Flue Length	8m
Max. Insulated Flexible Flue Length	30m*
Max. Flue Length	40m*
Flue Clearances to Combustibles	50mm for the first 1.2m of flue run
Flue Bends Allowed	Max. 10 bends in any flue run

CAVITY INSTALLATION OPTION

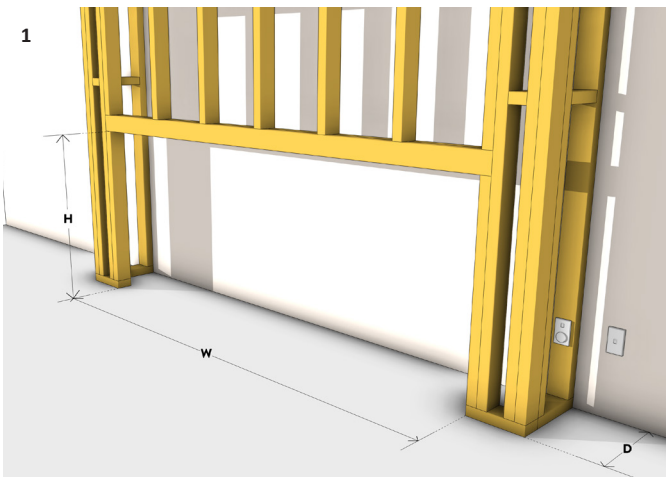

Build the chimney framework with consideration to flue pathways and meet the minimum fireplace opening requirements for a single sided installation (2418mm W x 928mm H x 365mm D). Ensure a continuous base for the fireplace.

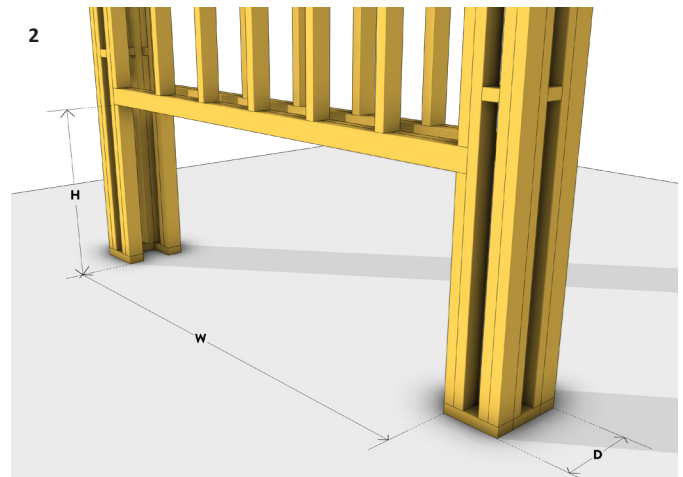

For a double sided installation build the chimney framework as above (2418mm W x 928mm H x 350mm D). Ensure a continuous base for the fireplace.

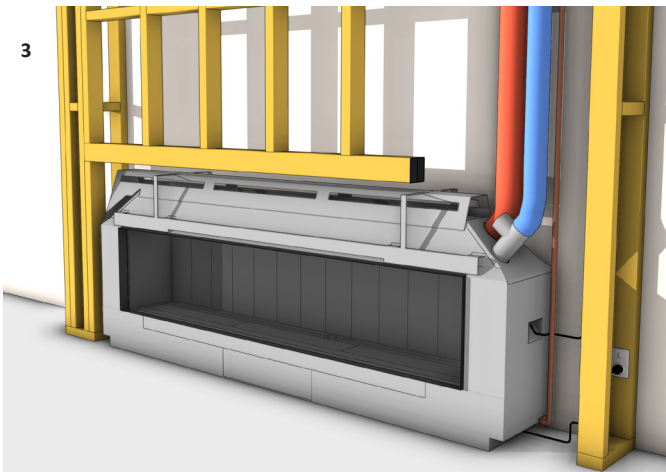

Install the appliance into the preformed cavity opening and secure it to the base. Ensure the fireplace is flush with the framework. Install electrical, network connections, and gas supply. Connect flue pipes to the fireplace and create the flue pathway to the terminal. Connect Powerflue electrical cable at both ends.

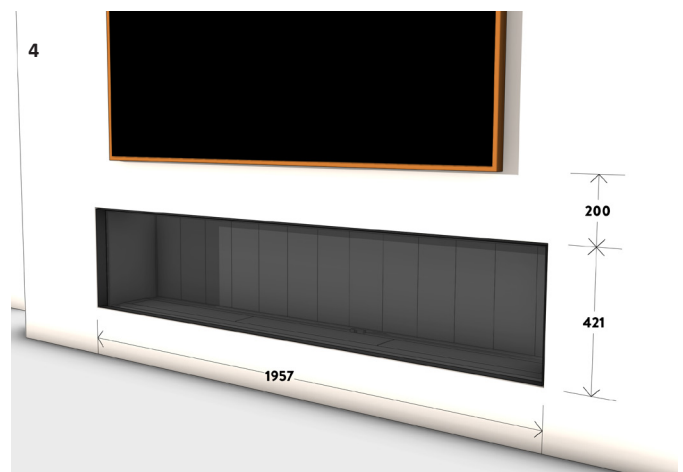

Attach wall linings to the framework and fireplace, maintaining a 5mm gap from the fireplace trim. Follow the provided wall lining cutout dimensions above for 10mm wall linings. Complete the project by adding additional finishes or fixtures.

INSTALLATION

The DS1900 suits a variety of cavity materials (combustible or non-combustible) and configurations, but is not suitable for installation into existing masonry chimneys.

The false cavity can be capped at the minimum cavity height, to allow installation below counters or into cabinetry.

Install the DS1900 on a firm, continuous surface such as concrete, plywood, or compressed cement sheet—never directly on carpet or heat-sensitive flooring.

Maintain required clearances to all surrounding surfaces and finishes; additional protection or extended trim kits may be needed for recessing or heat-sensitive materials.

When mounting a TV above the fireplace, keep the base at least **200mm** above the glass—note that this is a guideline only, and appliance compatibility remains the responsibility of the installer.

FINISHING

Use 10–20mm wall linings made from heat-resistant materials, ensuring they do not extend forward or beneath the 14mm trim. Maintain a 5mm (+/- 2mm) gap to the finishing trim, and where needed, use an **Extended Trim Kit** (22mm or 36mm) or a custom solution to protect against prolonged heat exposure, which can damage wall linings over time.

Specific finishing details are available via: www.stokefires.com/technical

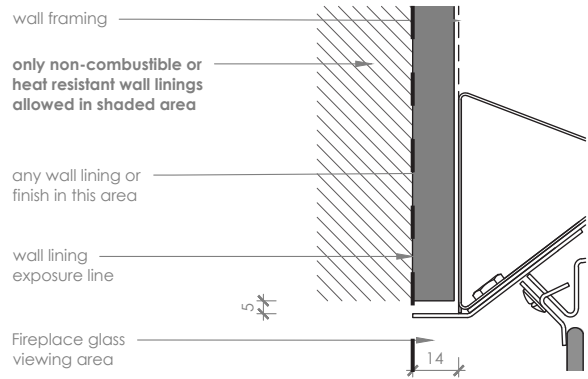

*This detail is applicable for all sides of the fireplace viewing area.

FIREPLACE AND CAVITY DIMENSIONS

Fireplace Width (W)	2279mm
Fireplace Height (H)	876mm
Fireplace Depth (D) including 14mm finishing trim	379mm

Cavity Opening Width min.	2418mm
Cavity Opening Height min.	928mm
*Sgl Sided Cavity Opening Depth min.	365mm
*Dbl Sided Cavity Opening Depth min.	350mm

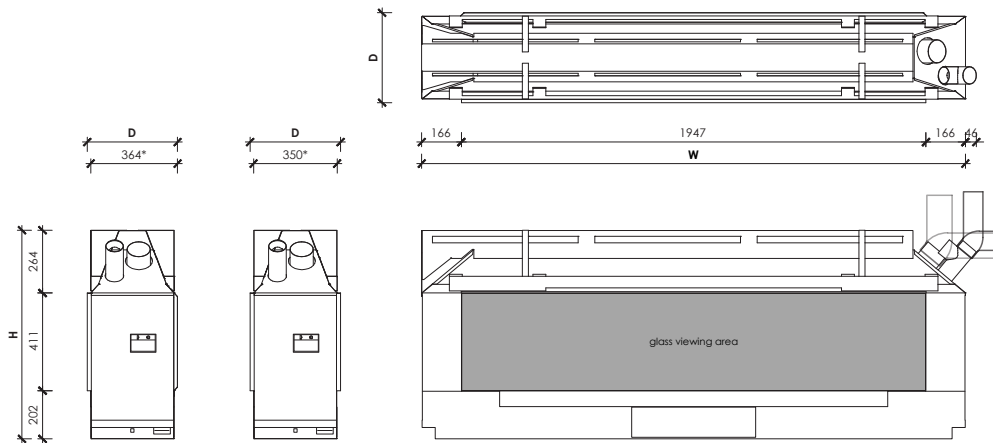

CLEARANCES TO COMBUSTIBLES

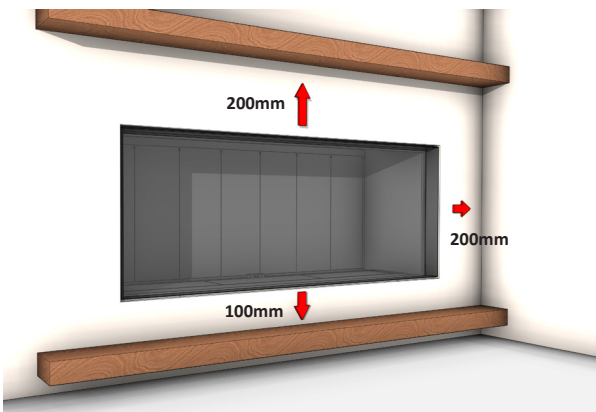

Following these clearances, will allow the use of standard building materials, whether combustible or non-combustible. It is recommended to keep furnishings at least **1m** from the front of the fireplace.

Ensure that any combustible mantels or protruding ledges above the fireplace are positioned at least **200mm** above the viewing area. Mantel height depends on its depth; the greater the mantel projection, the higher the clearance. A 100mm deep mantel must be at least 200mm above the fireplace opening. For more details, check the *Escea DS1900 Install Manual* at: www.escea.com/fireplace-specifications

A hearth is not necessary, but if used, a combustible hearth must be at least **100mm** below the glass viewing area or made entirely of non-combustible materials.

Where a wall protrudes forward of the fireplace, it must remain a minimum of **200mm** to the side of the fireplace viewing area.



Install Manual/CAD files are available via the QR Code or link: www.escea.com/technical

For Installation methods not covered in this document:
Email: aa@escea.com
PH (NZ): 0800 17 3000
PH (AU): 1800 460 832

Disclaimer:

Product dimensions and technical information are provided as a general guide and may not account for site-specific factors or installation constraints. Verify dimensions on-site before any manufacturing or installation. Specifications are subject to change