



For further information or specifications, visit the technical section of our website www.ambehome.com to view the latest product Installation Manual.

Appliance Information



Specifications	
Heat Output	1.6kW
Power Requirement	3 pin earthed 230V power outlet or a hard wire connection that can be isolated
Glass Size	1750W, 300H

Cavity Construction

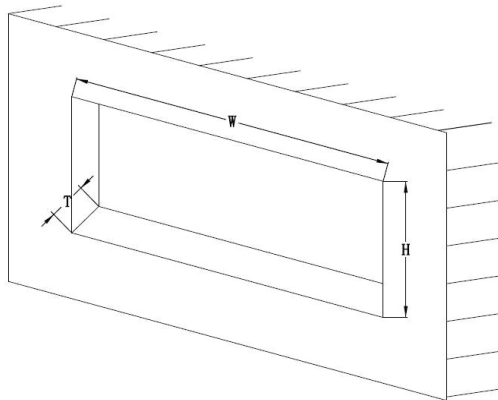

Minimum Framing Dimensions (mm)

W: 1775 mm
 H: 432 mm
 T: 170 mm

Clearances

Chassis Clearance

The fire chassis is zero clearance rated. Heat resistant material is not required for install.

The fire must be installed at least 30cm above the floor.

Cavity Base

This appliance **MUST** be fully supported on its base, over the entire area of the underside of the appliance. The base must also be level and strong enough to support the total product weight.

Clearance to Combustible Materials

Keep combustible materials including bedding, curtains, and clothes at least 1 m from the front of the fire.

