

# KS1460 Double Sided Gas Fireplace

Information Sheet for Builders and Architects

MODE

## SPECIFICATIONS

Heat Output	8.6kw
Gas Input	41 MJ/hr (NG) 38 MJ/hr (ULPG/Propane)
Gas Connection	Lower rear of fireplace - 1/2" BSPT Male
Gas Type	Natural Gas, Propane or ULPG
Power Requirement	3 pin, 230V AC mains power within 1m
Operation	Thermostatic Bluetooth remote control
Appliance Weight	160kg
Connections	Lower rear of fireplace
Clearance to Combustibles	Zero clearance from fireplace surfaces
Service Access Hatch	Not Required
Cavity Wall Venting	Not Required
Certification	Complies with AS/NZS 5263.1.3
Flue System	Power direct-vent with co-linear 100/75mm $\varnothing$ flexible and rigid PP flue pipes*



Flue Termination Locations	Roof or wall mounted terminations
Minimum Flue Length	400mm
Max. Uninsulated Flexible Flue Length	8m
Max. Insulated Flexible Flue Length	20m*
Max. Flue Length	40m*
Flue Clearances to Combustibles	50mm for the first 1.2m of flue run
Flue Bends Allowed	Max. 10 bends in any flue run

## CAVITY INSTALLATION OPTION

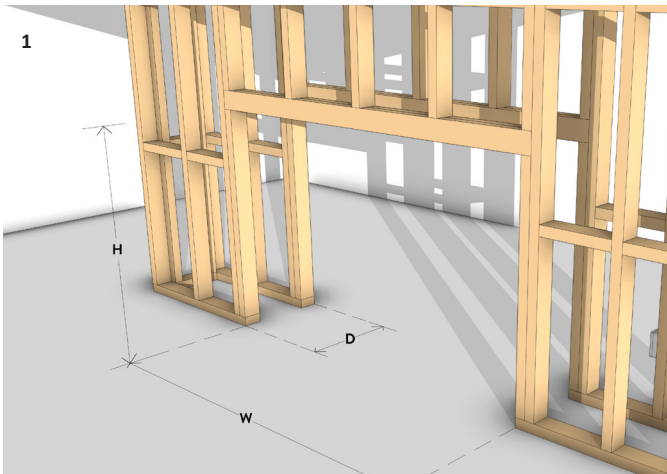

Build the chimney framework with consideration to flue pathways and meet the minimum fireplace opening requirement - **1735 W x 1090 H x 450 D**. Ensure a continuous base for the fireplace.

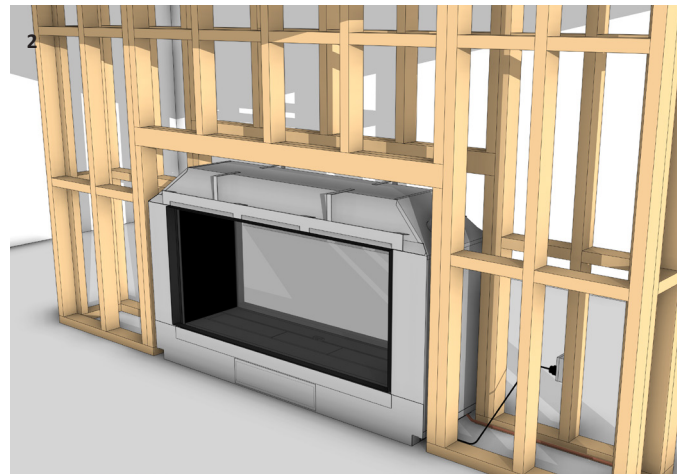

Install the appliance into the preformed cavity opening and secure it to the base. Ensure the fireplace is flush with the framework. Provide mains power connection and an accessible isolation switch. Install electrical, network connections, and gas supply.

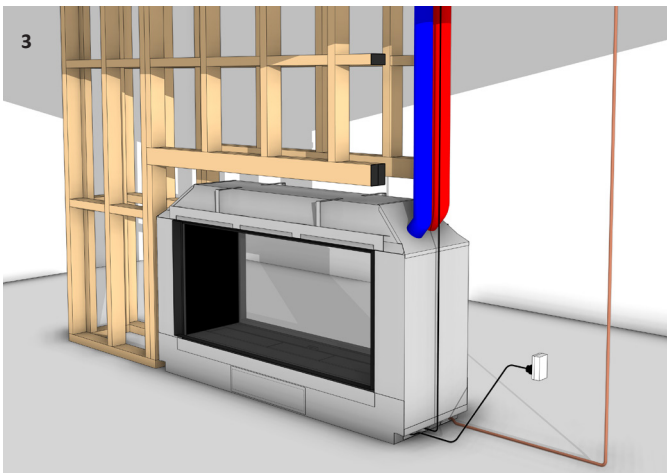

Connect flue pipes to the fireplace and create the flue pathway to the terminal. Connect Powerflue electrical cable at both ends.

\*Framework removed for clarity.

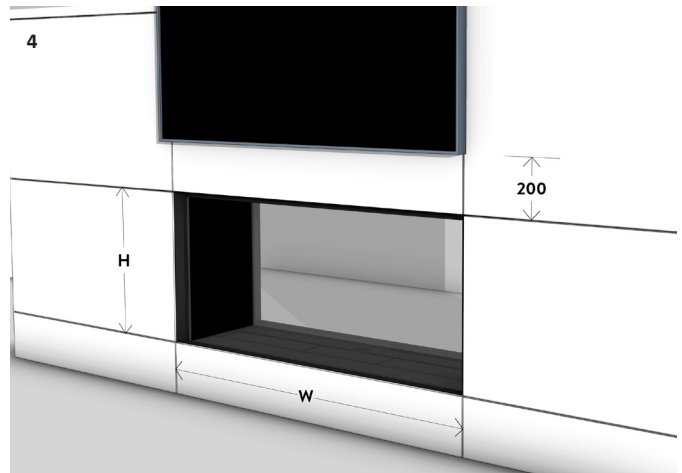

Attach wall linings to the framework, maintaining a 3mm gap from the fireplace trim. Follow the provided wall lining cutout dimensions - **1366 W x 607 H**. Complete the project by adding additional finishes or fixtures.

# KS1460 Double Sided Gas Fireplace

Information Sheet for Builders and Architects

MODE

## CAVITY OPTIONS

The KS1460 Double Sided gas fireplace is versatile for room installations in different configurations. The cavity surrounding the fireplace can be made from various materials, both combustible and non-combustible. Extra heat protection may be necessary for recessing or joinery specifications. Contact the Escea Architectural Advisory Team for further assistance.

## FIREPLACE BASE

Install the fireplace on a minimum 12mm firm, continuous surface like a concrete floor, plywood, or compressed cement sheet. Avoid installing directly on carpet, rugs, or heat-sensitive floor finishes.

## TV CLEARANCE

When mounting a TV or electrical appliance above a fireplace, this can be completed surface-mounted or recessed. Ensure the TV's base is at least **200mm** above the glass viewing area. Note that TV clearance recommendations are suggestions only, and Escea is not responsible for their compatibility with all electrical appliances.

## FIREPLACE AND CAVITY DIMENSIONS

Fireplace Width (A)	1695mm
Fireplace Height (B)	1000mm
Fireplace Depth (C) including 22mm finish trim	495mm
Cavity Opening Width min.	1735mm
Cavity Opening Height min.	1090mm
Cavity Opening Depth min.	450mm

## FINISHES

Use **18 - 20mm deep wall linings or finishes**, taking care to select materials suitable for the installation. Prevent combustible or heat sensitive wall linings from extending past or around the 22mm fireplace trim.

Maintain a 3mm gap (+2mm) to the fireplace's finishing trim.

Replace the 22mm fireplace trim with the **36mm Extended Trim Kit** or a custom solution, for adequate heat protection. Prolonged heat exposure may damage the appearance or long-term performance of wall linings.

For specific finish details, refer to: [www.stokefires.com/fireplace-specification](http://www.stokefires.com/fireplace-specification)

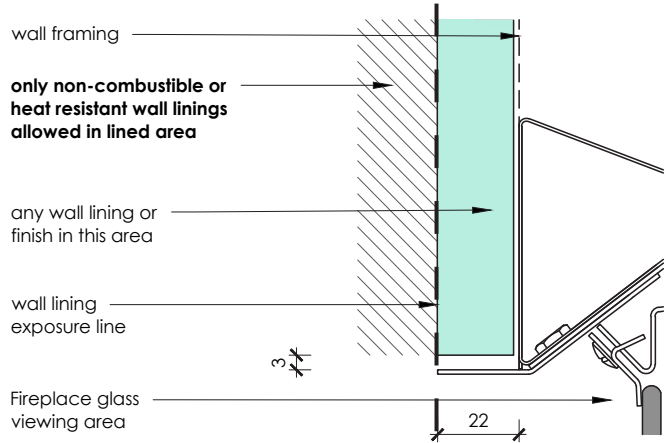

\*This detail is applicable for all sides of the fireplace viewing area.

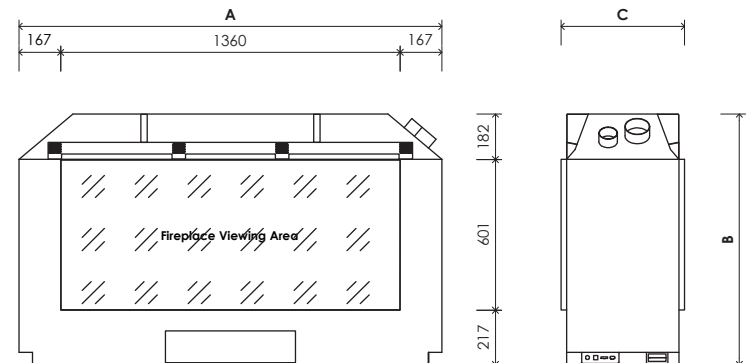

## FIREPLACE CLEARANCES TO COMBUSTIBLES

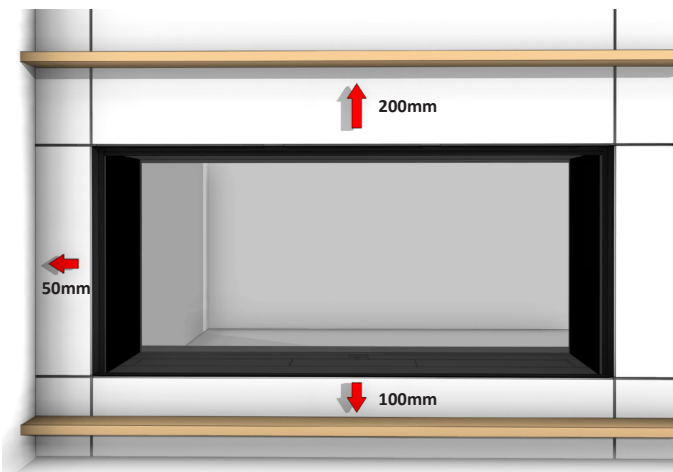

Ensure all clearances are met to any combustible or heat sensitive materials in front, above, to the side, or below the fireplace viewing area. Following these clearances, will allow the use of standard building materials, whether combustible or non-combustible. To reduce these clearances, use non-combustible materials.

Ensure that any combustible mantels or protruding ledges above the fireplace are positioned at least **200mm** above the viewing area. Mantel height depends on its depth; the greater the protrusion, the higher the clearance. For more details, check the *Mode KS1460 Single/Double Install Manual* at: [www.stokefires.com/fireplace-specification](http://www.stokefires.com/fireplace-specification)

A hearth is not necessary, but if used, a combustible hearth must be at least **100mm** below the glass viewing area or made entirely of non-combustible materials.

Install in accordance with *AS/NZS5601.1* and the *Mode KS1460 Single/Double Install Manual*. Contractors and installers should verify all dimensions on site prior to the manufacture or construction of any structure or finishes.

## FURTHER INFORMATION

Where an installation scenario is not covered within this document or the *Mode KS1460 Single/Double Install Manual*, please contact the Escea Architectural Advisory Team for further assistance.

Email: [aa@escea.com](mailto:aa@escea.com)

PH (NZ): **0800 17 3000**

PH (AU): **1800 460 832**