

KS1460 Corner Gas Fireplace

Information Sheet for Builders and Architects

MODE

SPECIFICATIONS

Heat Output	8.6kw
Gas Input	41 MJ/hr (NG) 38 MJ/hr (ULPG/Propane)
Gas Connection	Lower rear of fireplace - 1/2" BSPT Male
Gas Type	Natural Gas, Propane or ULPG
Power Requirement	3 pin, 230V AC mains power within 1m
Operation	Thermostatic Bluetooth remote control
Appliance Weight	250kg (160kg excluding KWU)
Connections	Lower rear of fireplace
Clearance to Combustibles	Zero clearance from fireplace surfaces
Service Access Hatch	Not Required
Cavity Wall Venting	Not Required
Certification	Complies with AS/NZS 5263.1.3
Flue System	Power direct-vent with co-linear 100/75mm \varnothing flexible and rigid PP flue pipes*



Flue Termination Locations	Roof or wall mounted terminations
Minimum Flue Length	1.2m
Max. Uninsulated Flexible Flue Length	8m
Max. Insulated Flexible Flue Length	20m*
Max. Flue Length	40m*
Flue Clearances to Combustibles	50mm for the first 1.2m of flue run
Flue Bends Allowed	Max. 10 bends in any flue run

CAVITY INSTALLATION OPTION

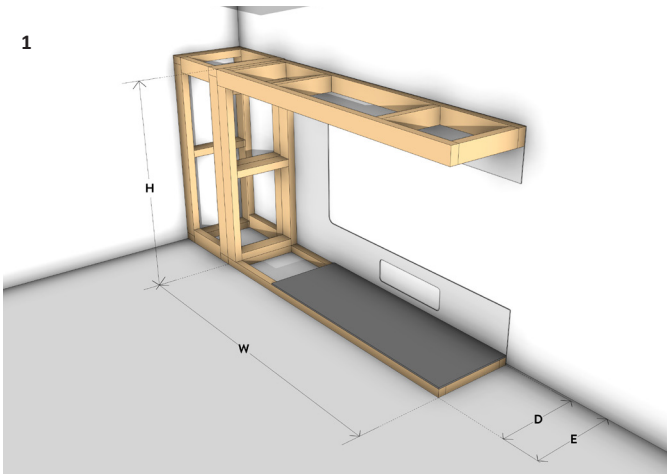

Build the KS1460 KWU framework and fit the rear panel - **1850 W x 1200 H x 453 D**. Surrounding framework and KWU must be **466mm (E)** off the rear wall. Consider the flue pathway. Ensure a continuous base for the fireplace.

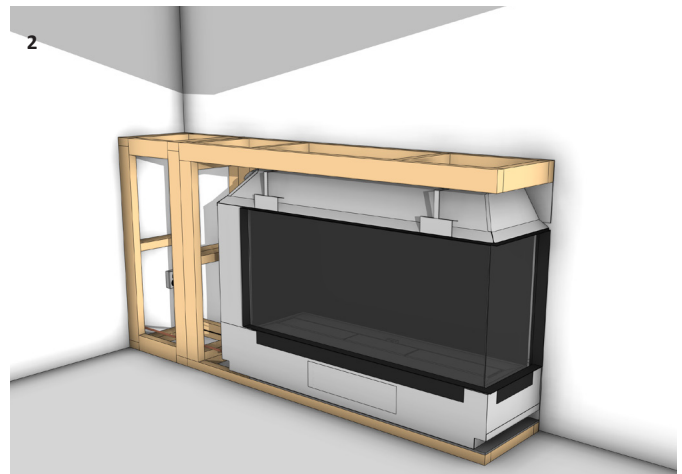

Install the appliance into the KWU Framework and secure it to the base. Ensure the fireplace is flush with the framework. Provide mains power connection and an accessible isolation switch. Install electrical, network connections, and gas supply.

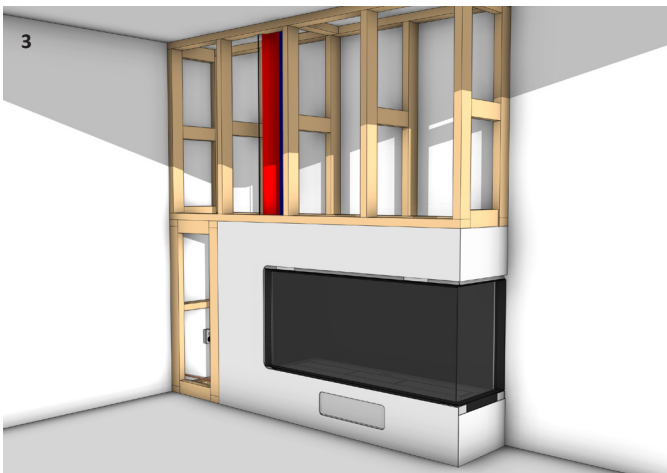

Connect flue pipes to the fireplace and create the flue pathway to the terminal. Connect Powerflue electrical cable at both ends. Fit KWU last side and front panels onto framework. Build the remainder of the framework where required.

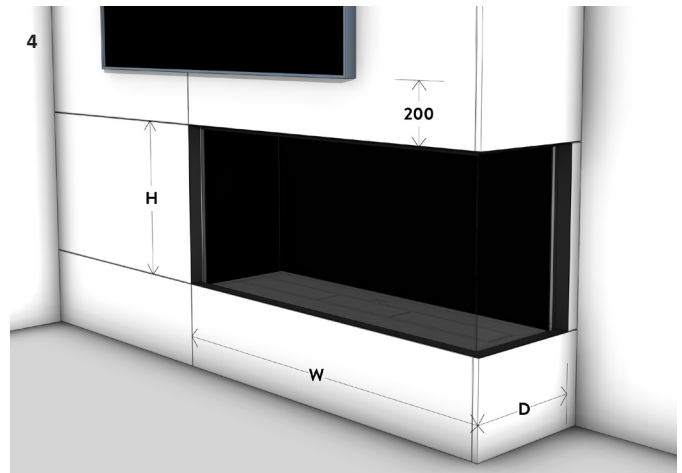

Attach wall linings to the framework and KWU, maintaining a 3mm gap from the fireplace trim. Follow the wall lining cutout dimensions - **1408 W x 607 H x 434 D**. Complete the project by adding additional finishes or fixtures.

*Refer to the *Mode KS1460 Corner Flue Selection Guide*

KS1460 Corner Gas Fireplace

Information Sheet for Builders and Architects

MODE

CAVITY OPTIONS

The KS1150 Corner gas fireplace is available in both left and right corner options, with the short side of glass positioned to the left for the left option and to the right for the right option, when facing the fireplace. The cavity surrounding the fireplace can be made from various materials, both combustible and non-combustible. Extra heat protection may be necessary for recessing or joinery specifications.

Please Note: The KS1460 Gas fireplace must be installed with the KS1460 Kitset Wall Unit (KWU).

KITSET WALL UNIT

The KS1460 Corner must be installed within the provided Kitset Wall Unit (KWU), serving as a robust metal support structure capable of bearing up to 500kg of framework and cladding without transmitting load to the fireplace. It is essential to note that existing cavities are not suitable for installation. The upper, lower, and end frames are constructed using timber framework, while 3mm steel sheet panels encase the fireplace on its sides and front. The installation surface should be a firm, continuous 9mm surface such as plywood, OSB, or fiber cement sheet.

Please Note: KWU side panels increase wall lining depth by 3mm, potentially requiring wall packing adjustments.

TV CLEARANCE

When mounting a TV or electrical appliance above a fireplace, this can be completed surface-mounted or recessed. Ensure the TV's base is at least **200mm** above the glass viewing area. Note that TV clearance recommendations are suggestions only, and Escea is not responsible for their compatibility with all electrical appliances.

FIREPLACE AND CAVITY DIMENSIONS

Fireplace with KWU Width (A) including 22mm finish trim	1875mm
Fireplace with KWU Height (B)	1200mm
Fireplace with KWU Depth (C) including 22mm finish trim	490mm
KWU Cavity Opening Width min.	1853mm
KWU Cavity Opening Height min.	1200mm
KWU Cavity Opening Depth min. (includes 2x 3mm side panels)	469mm

FINISHES

Use **18 - 20mm deep wall linings or finishes**, taking care to select materials suitable for the installation. Prevent combustible or heat sensitive wall linings from extending past or around the 22mm fireplace trim.

Maintain a 3mm gap (+2mm) to the fireplace's finishing trim.

Replace the 22mm fireplace trim with the **36mm Extended Trim Kit** or a custom solution, for adequate heat protection. Prolonged heat exposure may damage the appearance or long-term performance of wall linings.

For specific finish details, refer to: www.stokefires.com/fireplace-specification

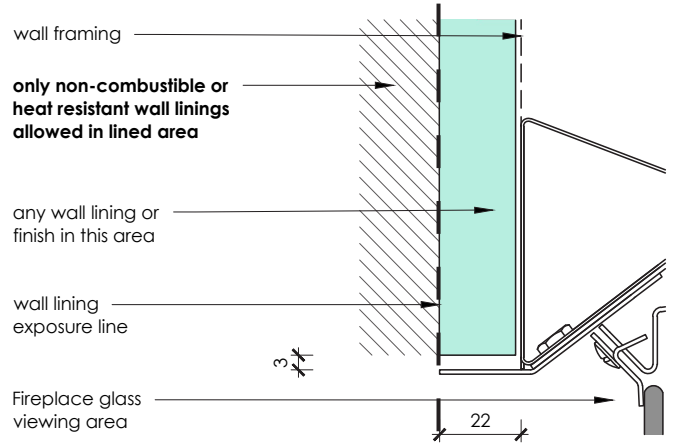

*This detail is applicable for all sides of the fireplace viewing area.

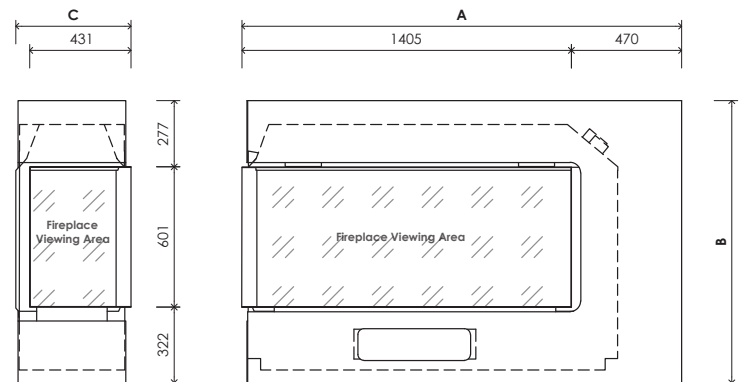

FIREPLACE CLEARANCES TO COMBUSTIBLES

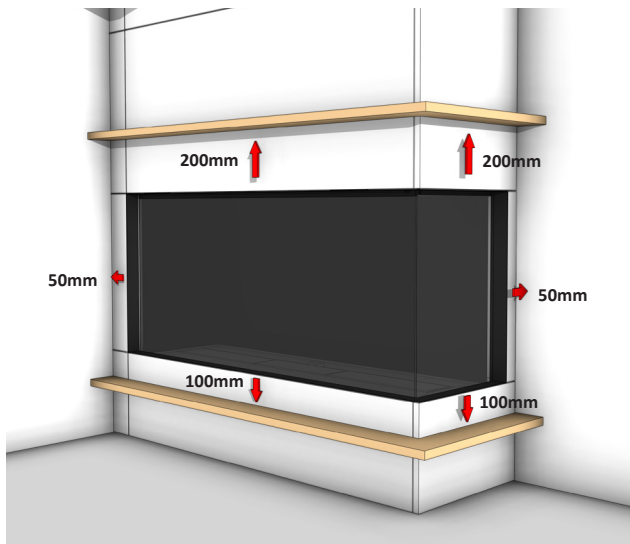

Ensure all clearances are met to any combustible or heat sensitive materials in front, above, to the side, or below the fireplace viewing area. Following these clearances, will allow the use of standard building materials, whether combustible or non-combustible. To reduce these clearances, use non-combustible materials.

Ensure that any combustible mantels or protruding ledges above the fireplace are positioned at least **200mm** above the viewing area. Mantel height depends on its depth; the greater the protrusion, the higher the clearance. For more details, check the *Mode KS1460 Corner Install Manual* at: www.stokefires.com/fireplace-specification

A hearth is not necessary, but if used, a combustible hearth must be at least **100mm** below the glass viewing area or made entirely of non-combustible materials.

FURTHER INFORMATION

Install in accordance with AS/NZS5601.1 and the *Mode KS1460 Corner Install Manual*. For Installation methods not covered in this document please contact:

Email: aa@escea.com PH (NZ): 0800 17 3000 PH (AU): 1800 460 832

Disclaimer:

Dimensions provided are indicative and may not consider all site-specific variations or installation needs. Verify dimensions on-site before manufacturing or construction.